

NAVODILA ZA UPORABO

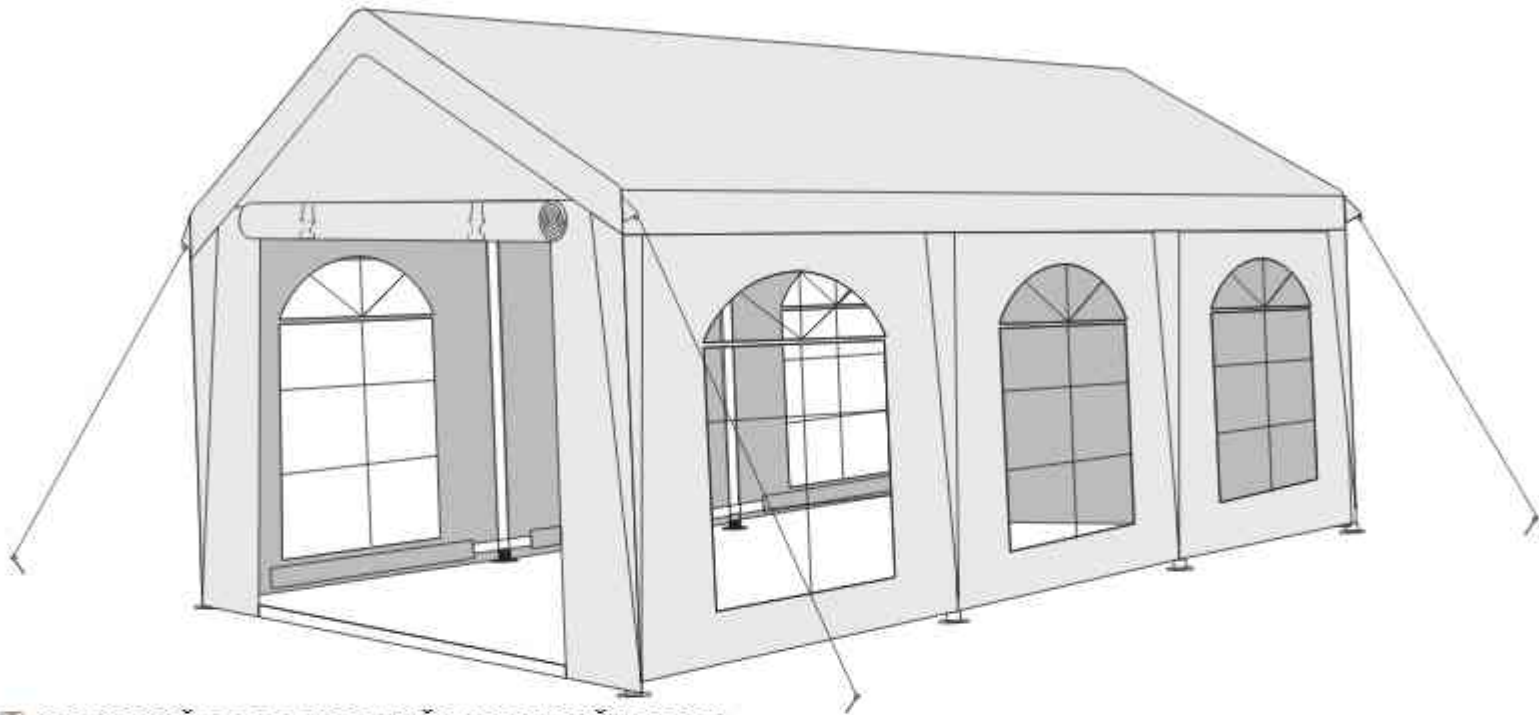

PRIPOROČILA ZA MONTAŽO IN VZDRŽEVANJE

Ekipna montaža: Glede na dimenzije 4x6 m in število komponent (npr. 34 kosov vijakov M6*50 in 62 kosov elastičnih zank) priporočamo, da montažo izvajata vsaj 2 do 3 odrasli osebi.

Pregled spojev: Med montažo in redno med uporabo preverjajte privitost vseh vijajčnih spojev (L, O, R) in stabilnost spojnikov (D, E, H, J).















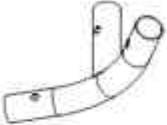



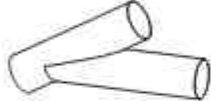

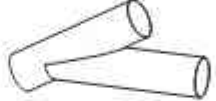
Shranjevanje: Pred shranjevanjem se prepričajte, da so vsa platna (T, U, V) in kovinski deli (A, B, C) popolnoma suhi in čisti. Shranjevanje v vlažnem stanju lahko povzroči nastanek plesni na platnih ali korozijo materiala.

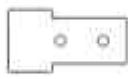
PRAVNA IZJAVA O ODGOVORNOSTI

Omejitev odgovornosti: Proizvajalec in prodajalec ne prevzemata odgovornosti za premoženjsko škodo, telesne poškodbe ali izgube, ki so posledica nepravilne montaže, zanemarjanja vzdrževanja ali neupoštevanja varnostnih navodil v tem priročniku.

Višja sila: Garancija ne krije škode, ki jo povzroči višja sila (ekstremno vreme, poplave, neurja). V takšnih razmerah je uporabnik dolžan šotor pravočasno zavarovati ali razstaviti.

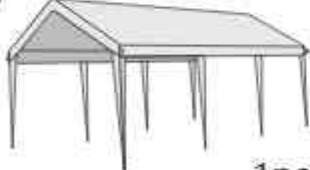
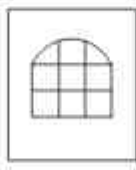
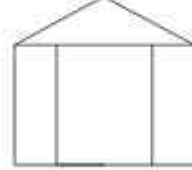
Namen uporabe: Uporaba šotora za namene, ki niso predvideni (npr. kot skladišče, garaža za vozila ali trajno zavetje), je na lastno odgovornost uporabnika in vodi do izgube pravice do reklamacije.

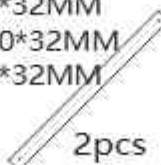
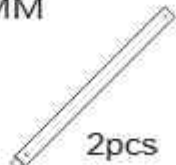
<p>A 1873*38MM</p>  <p>8pcs</p>	<p>A1 (4x6M) 250*38MM (5x6M) 760*38MM (6x6M) 1270*38MM</p>  <p>8pcs</p>	<p>B 1873*38MM</p>  <p>9pcs</p>	<p>C 1920*38MM</p>  <p>8pcs</p>
<p>D</p>  <p>6pcs</p>	<p>E</p>  <p>6pcs</p>	<p>F (4x6M) 1066*38MM (5x6M) 1066*38MM (6x6M) 1920*38MM</p>  <p>4pcs</p>	<p>G 1920*32MM</p>  <p>12pcs</p>
<p>H</p>  <p>8pcs</p>	<p>I 880*38MM</p>  <p>4pcs</p>	<p>J</p>  <p>8pcs</p>	<p>K</p>  <p>8pcs</p>
<p>L</p>  <p>12pcs</p>	<p>M</p>  <p>16pcs</p>	<p>N</p>  <p>16pcs</p>	<p>O</p>  <p>M6*50 34pcs</p>
<p>P</p>  <p>28pcs</p>	<p>Q</p>  <p>4pcs</p>	<p>R</p>  <p>24pcs</p>	<p>S</p>  <p>2pcs</p>
<p>T</p>  <p>1pcs</p>	<p>U</p>  <p>6pcs</p>	<p>V</p>  <p>2pcs</p>	<p>W</p>  <p>62pcs</p>
<p>X 1920*32MM</p>  <p>4pcs</p>	<p>Y 330*32MM (4x6M) 330*32MM (5x6M) 1330*32MM (6x6M) 330*32MM</p>  <p>2pcs</p>	<p>Y1 (6x6M) 1920*32MM</p>  <p>2pcs</p>	

STEP 1



(A) X2



(A1) X2



(D) X1

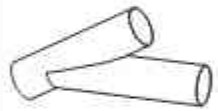

(H) X2



(F) X2

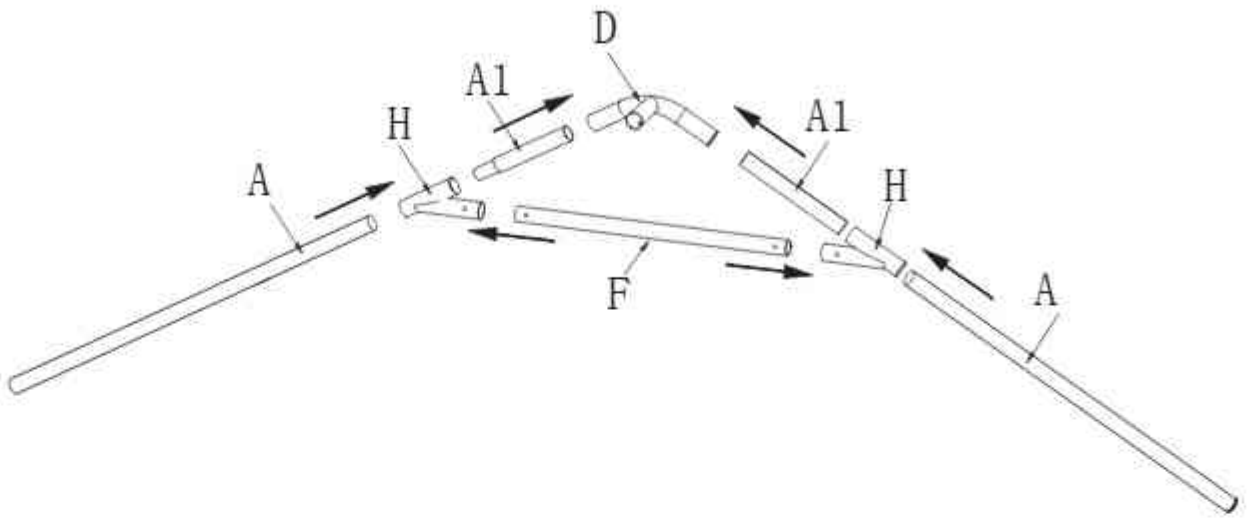

STEP 2



(D) X2

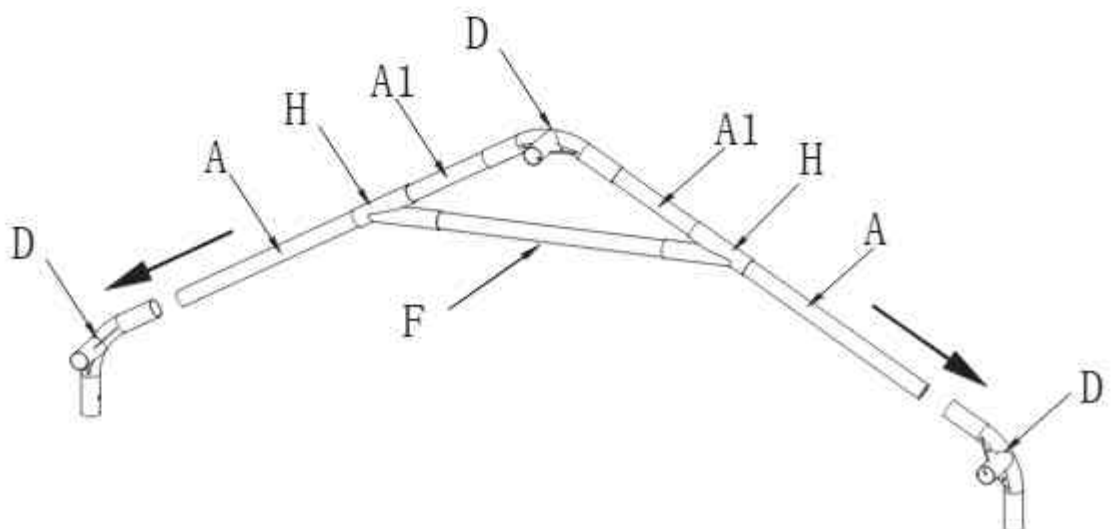

STEP 3

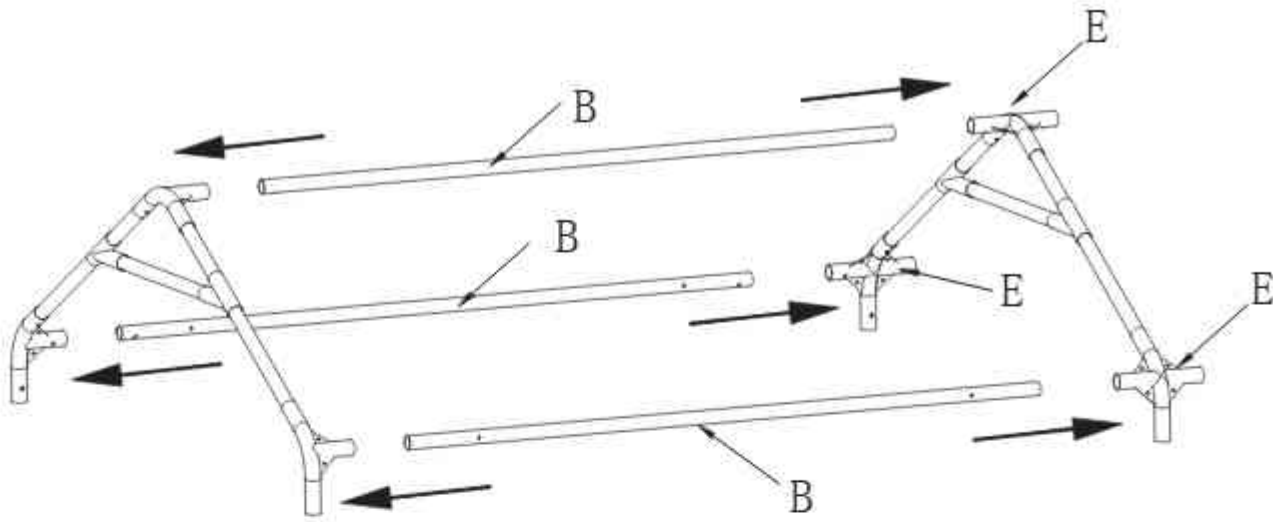

(B) X3



(E) X3

STEP 4

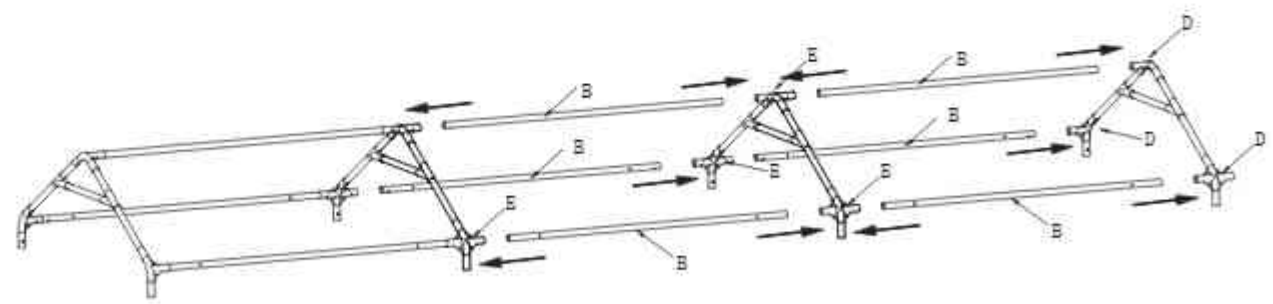

X1

X1

(B) X6

STEP 5

(G) X6

(I) X16

(M) X8

(N) X8

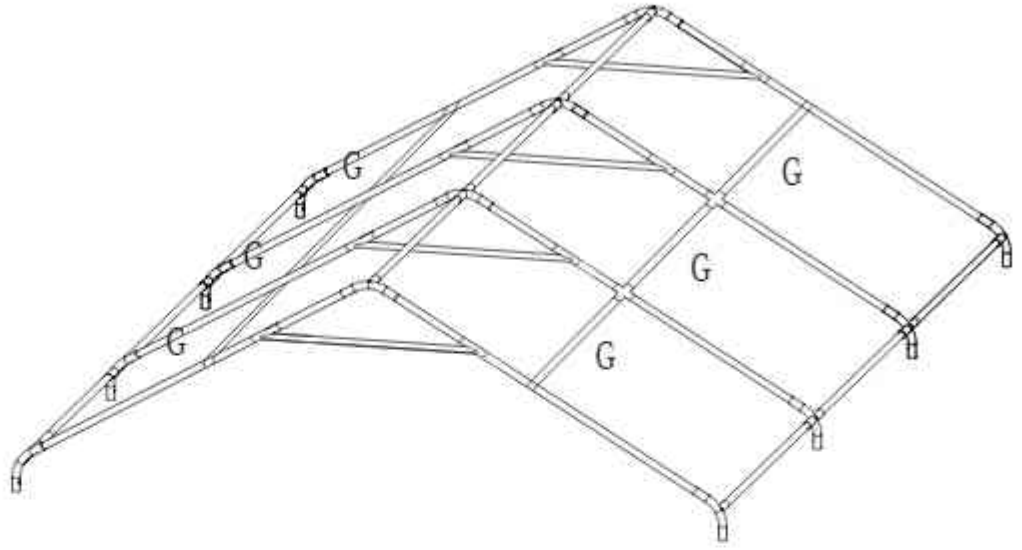

STEP 6

(T) X1

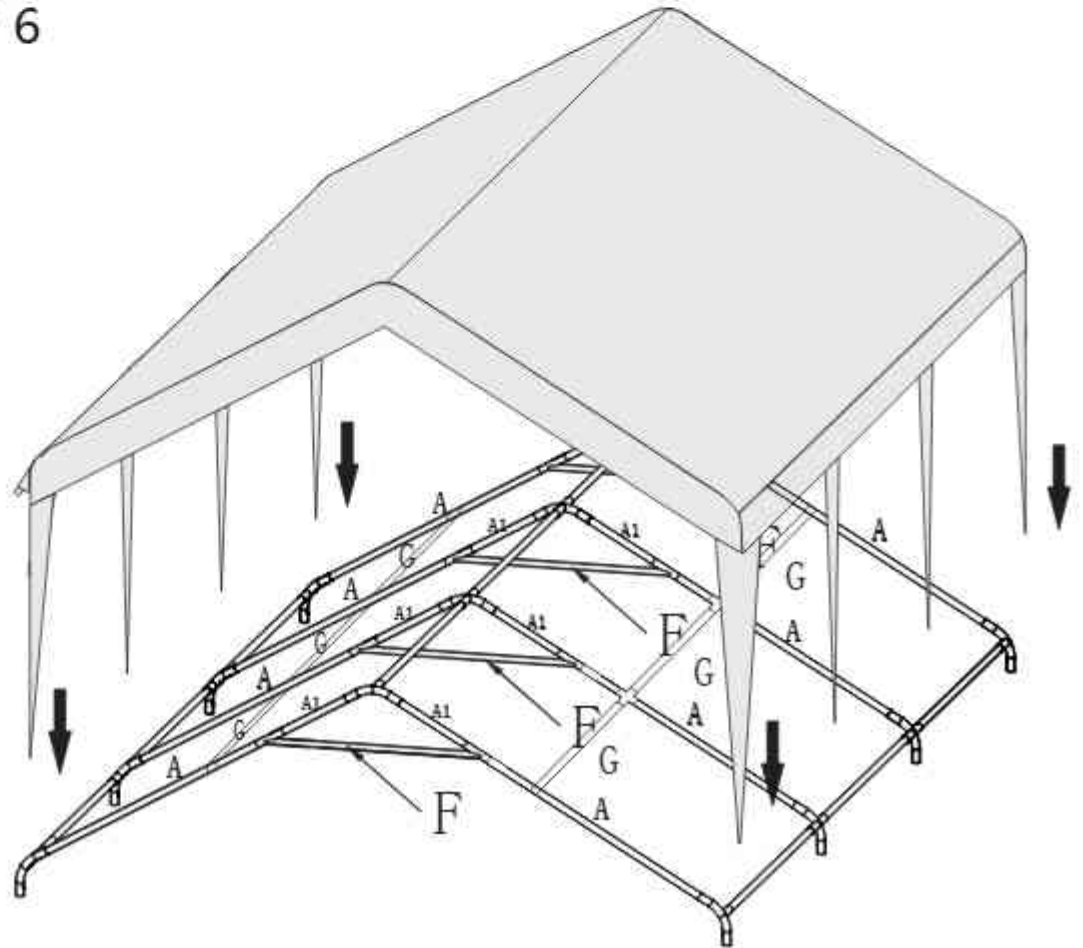

STEP 7

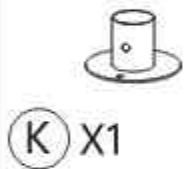
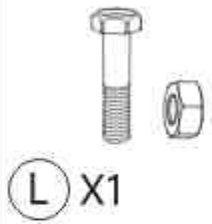
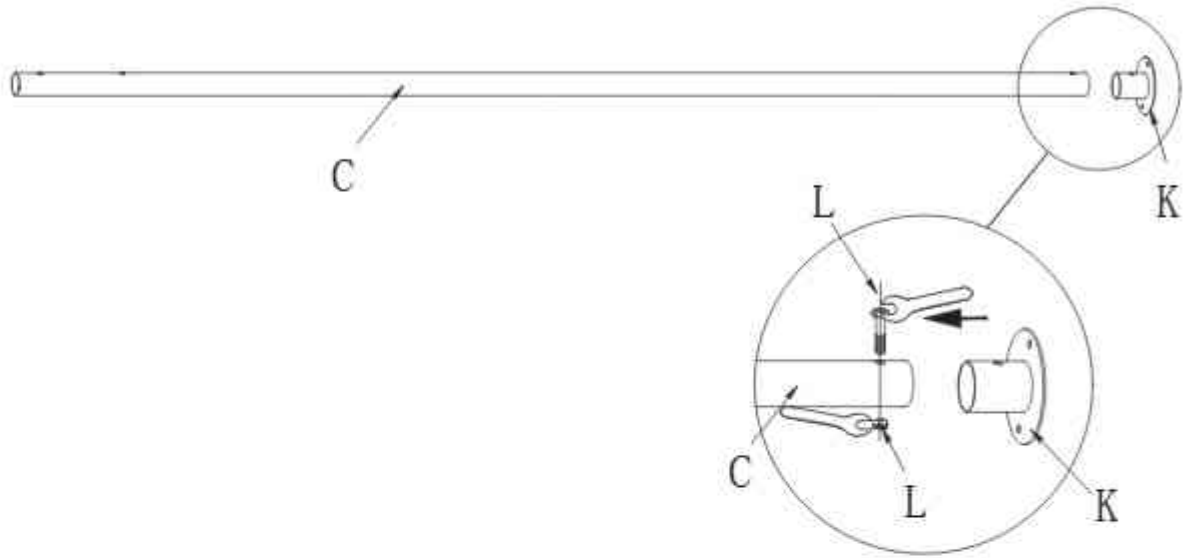

STEP 8

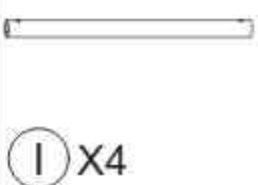
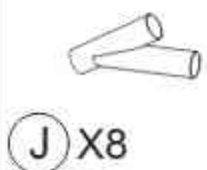
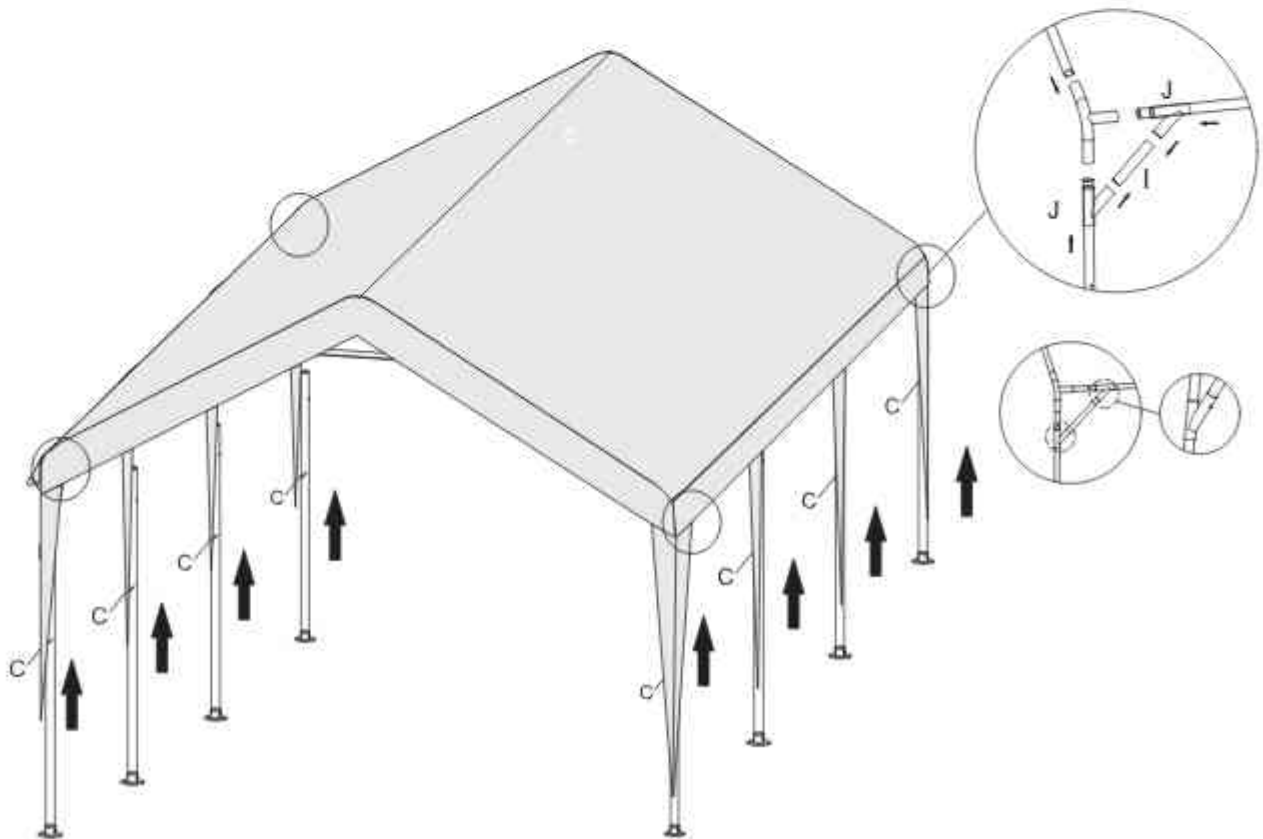



STEP 9

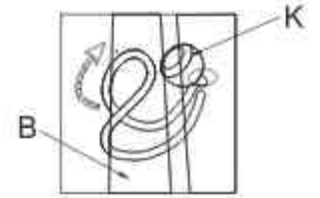

U X6

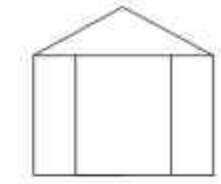
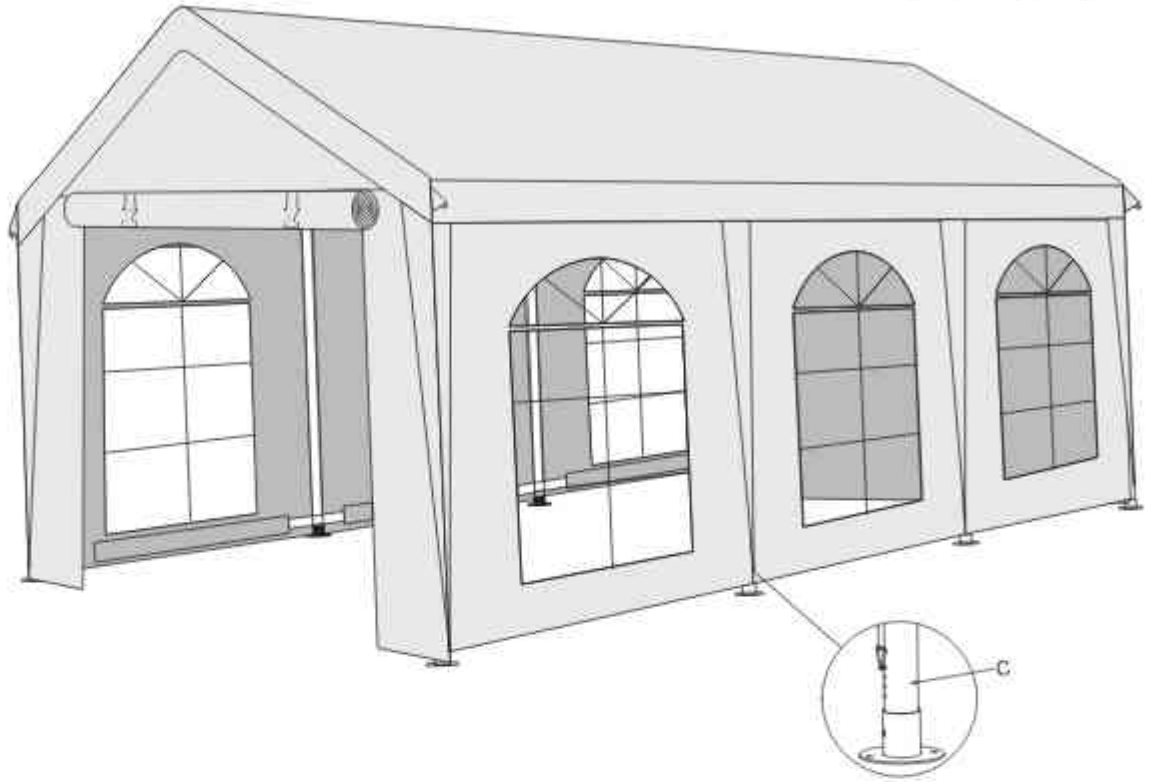

V X2



W X62

STEP 10

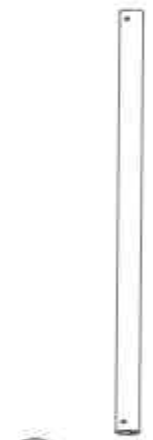

X X2



Y X1

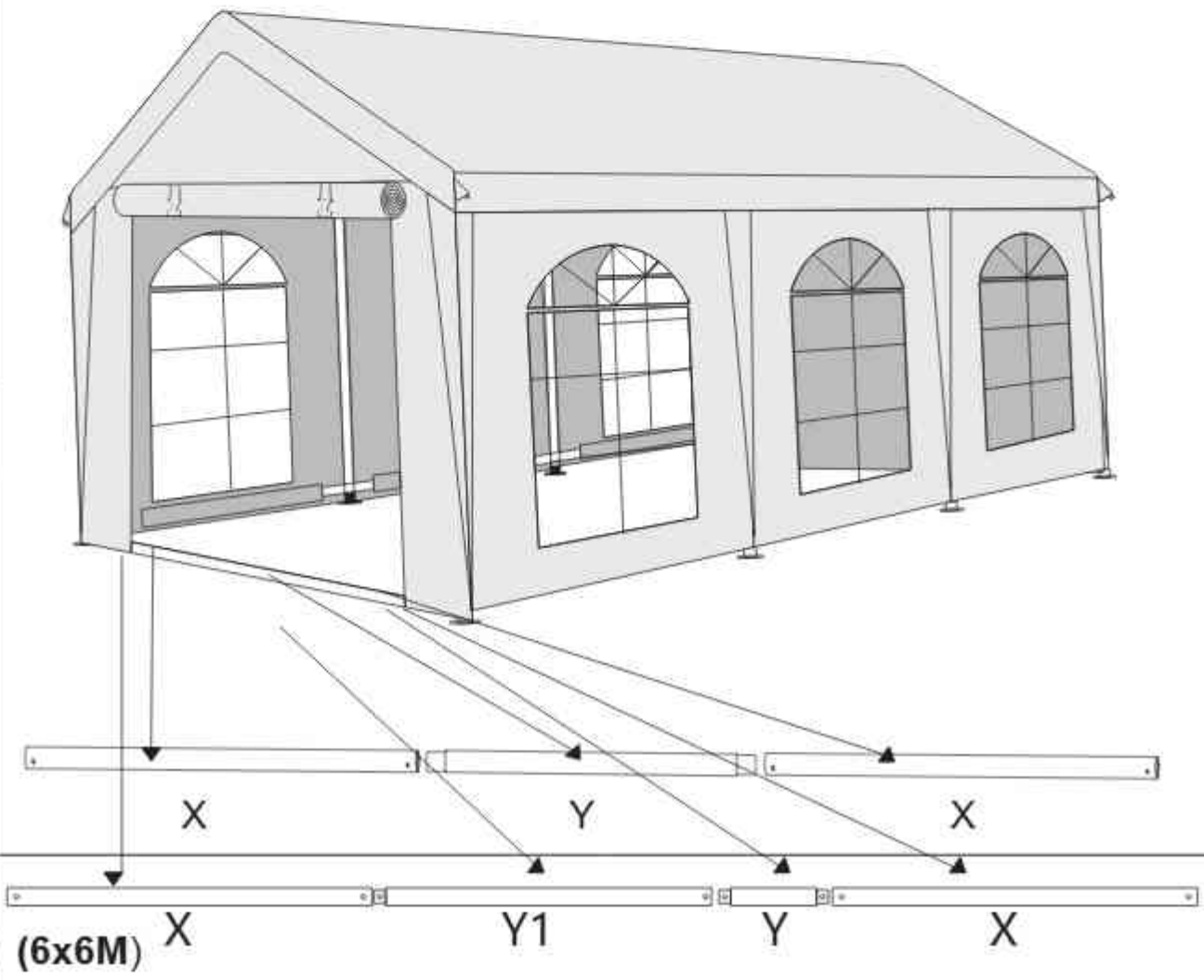

Y1 X1 (6x6M)

(6x6M) X Y1 Y X

STEP 11



G X6



M6*50

O X16



M X8



N X8

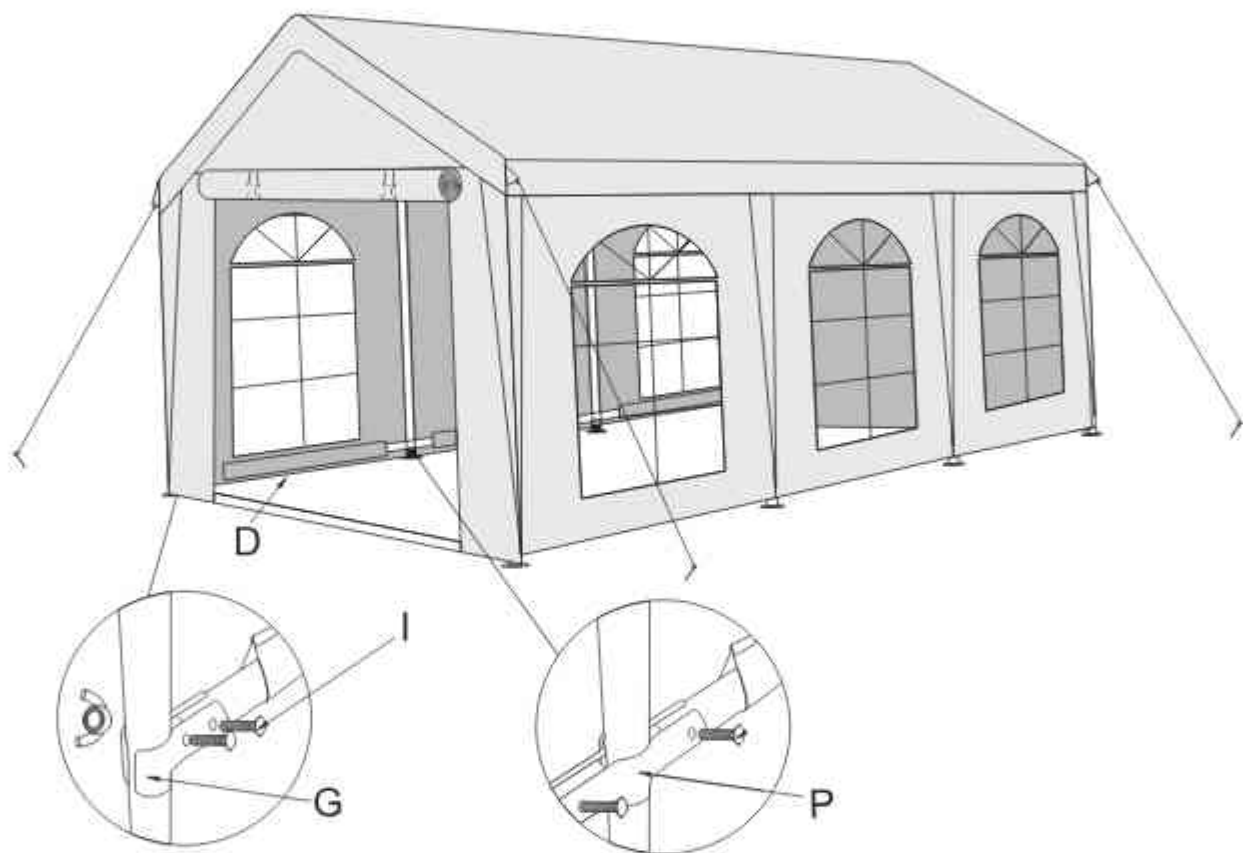

VARNOSTNO OPOZORILO Kratkotrajna uporaba:

Ta prireditveni šotor je zasnovan izključno kot začasno zavetje za kratkotrajne družabne dogodke. Ni namenjen trajni uporabi ali kot dolgoročna rešitev za pokrivanje. Obvezno sidranje: Šotor mora biti v vseh okoliščinah ustrezno pritrjen na tla s priloženimi klini (P), vrvmi (Q) in podstavki (K). Nikoli ne puščajte prostostoječega šotora brez nadzora. Vremenske razmere: V primeru napovedi neugodnega vremena, kot so močan veter, nevihta, toča ali močno sneženje, je treba šotor takoj podreti. Konstrukcija ni zasnovana za prenašanje ekstremnih obremenitev vetra ali snega. Požarna varnost: Znotraj šotora ali v njegovi neposredni bližini ne uporabljajte odprtega ognja, žarov, grelnikov ali drugih virov toplote. Obstaja nevarnost poškodbe ponjave (T, U, V) ali nastanka požara. Kopičenje vode in snega: Redno preverjajte strešno ponjavo (T), da preprečite kopičenje deževnice ali snega. Prekomerna teža lahko povzroči deformacijo kovinskih palic (A, B, C) ali zrušitev konstrukcije.

PODROBEN POSTOPEK MONTAŽE (TEHNIČNA LOGIKA)

Pri montaži sledite oštevilčenim korakom v slikovnih navodilih: Priprava strešnega okvirja (Korak 1 – 4): Najprej sestavite zgornji del konstrukcije (ostrešje). Uporabite sredinske vezne elemente (D, H) in palice (A, A1, F). Postopoma dodajajte vzdolžne palice (B) s pomočjo veznih elementov (E). Ojačitev strehe (Korak 5): Namestite strešne ojačitve (G). Te palice so ključne za stabilnost ponjave in odvajanje vode. Namestitev strešne ponjave (Korak 6): Strešno ponjavo (T) napnite na konstrukcijo, preden šotor dvignete na noge. To je varneje in preprosteje. Dvig na noge (Korak 7 – 8): Postopoma vstavljajte nožne palice (C) v vezne elemente. Na spodnji del vsake noge namestite podstavek (K). Namestitev sten in spodnjega okvirja (Korak 9 – 10): S pomočjo elastičnih zank (W) pritrдите stranske stene z okni (U) in vhodne dele (V). Na koncu povežite spodnje palice (X, Y) za maksimalno togost konstrukcije. Končno zavarovanje (Korak 11): Preverite, ali so vsi vijaki (O, R) priviti in ali je šotor trdno zasidran s klini (P) v tla.

DODATNA PRIPOROČILA ZA UPORABNIKA

Smer vetra: Če šotor postavljate v zmernem vetru, mora biti vhod obrnjen proti smeri vetra, da preprečite učinek "padala".

Zaščita tekstila: Pri zategovanju elastičnih zank (W) ne uporabljajte prekomerne sile, da ne bi iztrgali obročkov iz ponjave.





Garancija na korozijo: Čeprav so palice lakirane, priporočamo, da v primeru prask med montažo mesto zaščitite z antikorozijskim sprejem, saj gre za jekleno konstrukcijo.

POVEZAVA DVEH ŠOTOROV - za dolžino 12 m in več (PODALJŠANJE)

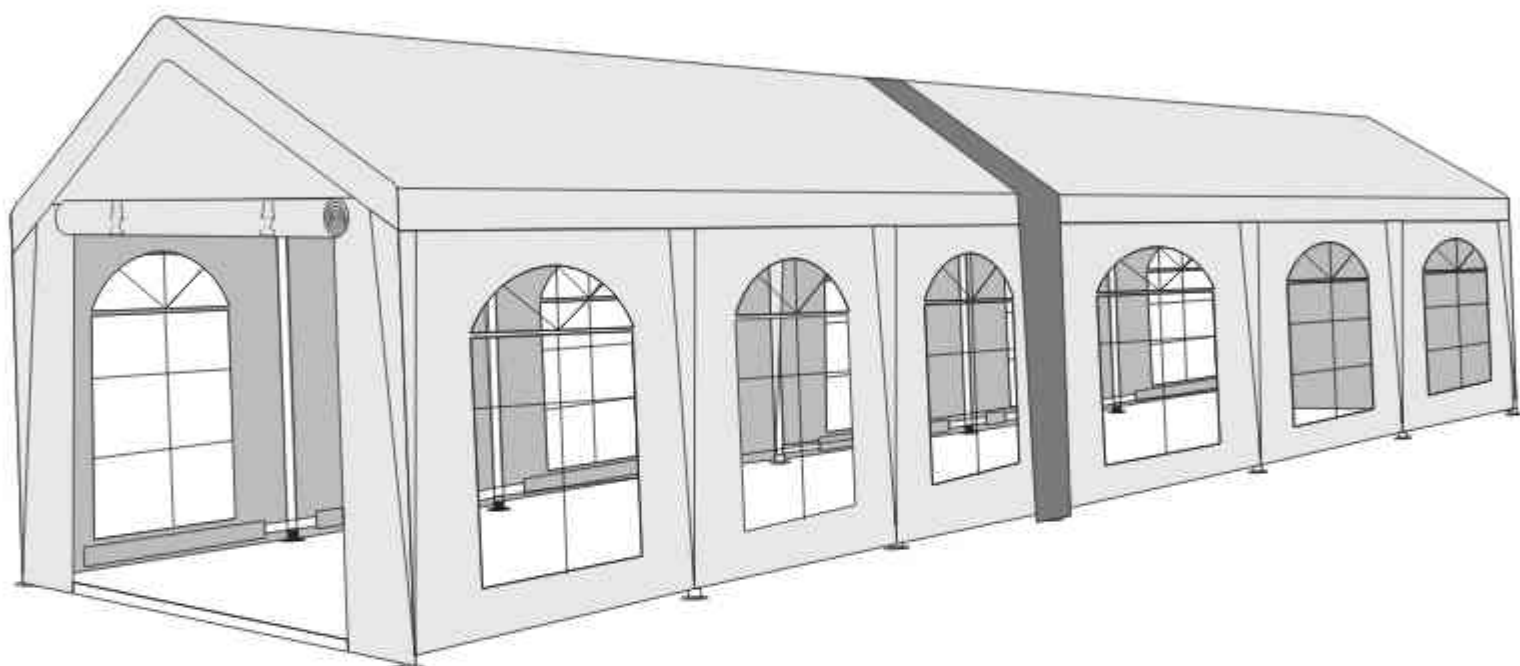
Ob nakupu šotora dolžine 12 m ali več je ta dodatek samodejno vključen v ceno.

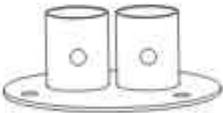
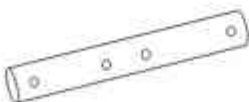
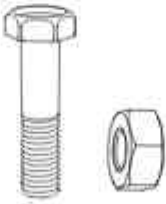
Pri šotorih 4x6 m, 5x6 m, 6x6 m je to dodatek za doplačilo.



A  2PCS	B  2PCS	C  4PCS	D  1PCS
E  2PCS	F  4PCS	G S 4PCS	

STEP 1

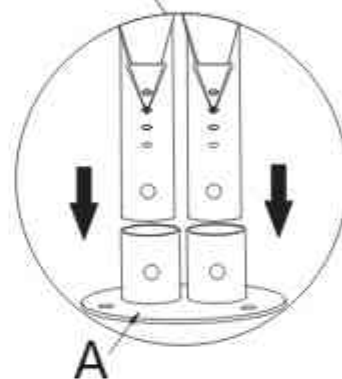
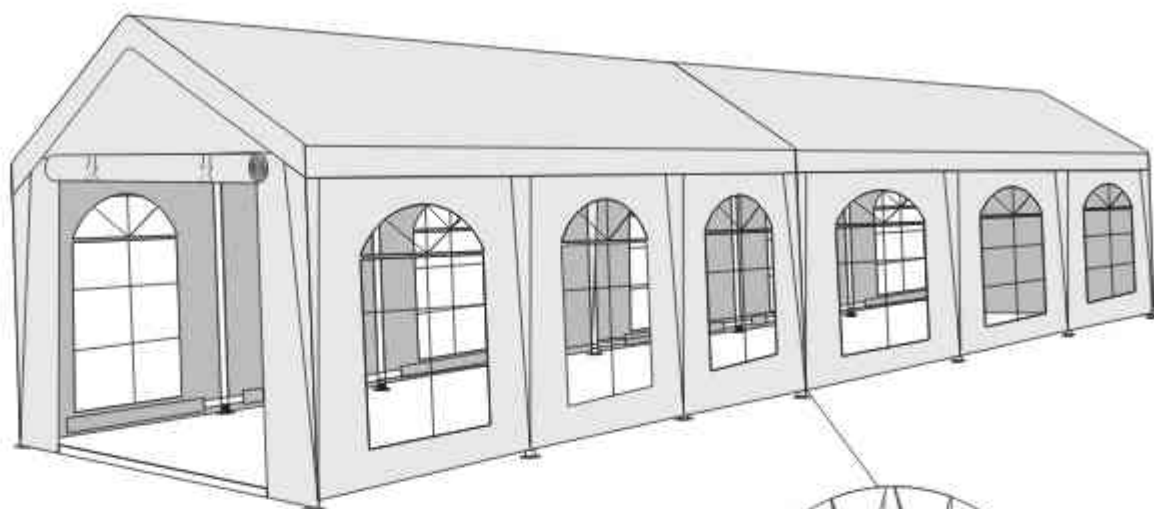
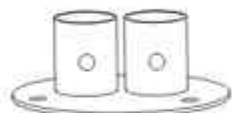

(A) X2

STEP 2

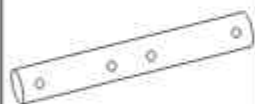

(B) X2



(C) X4



(E) X2

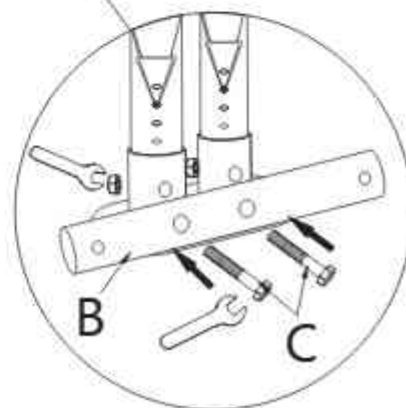
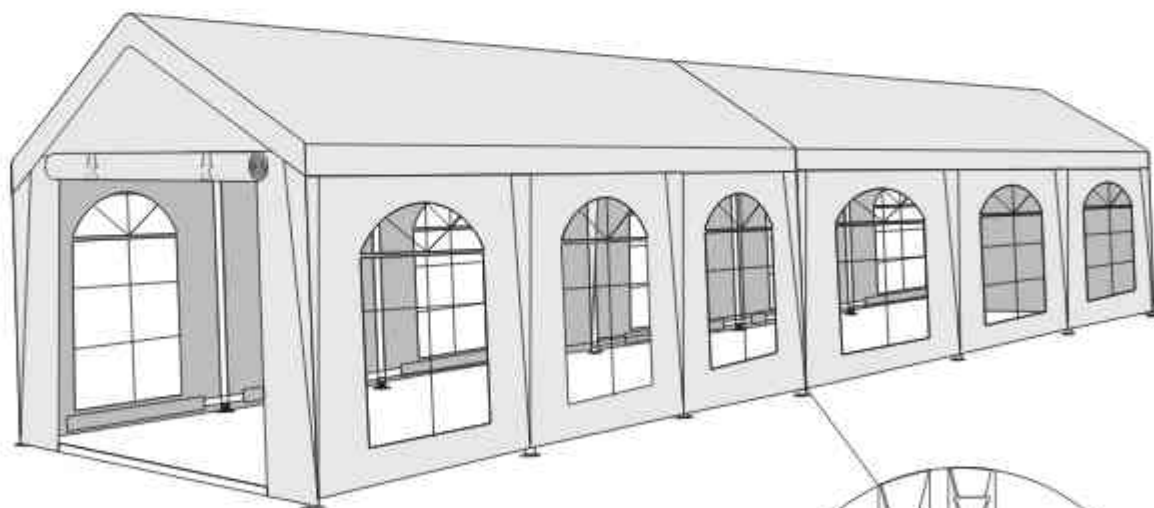

STEP 3



Ⓓ X1

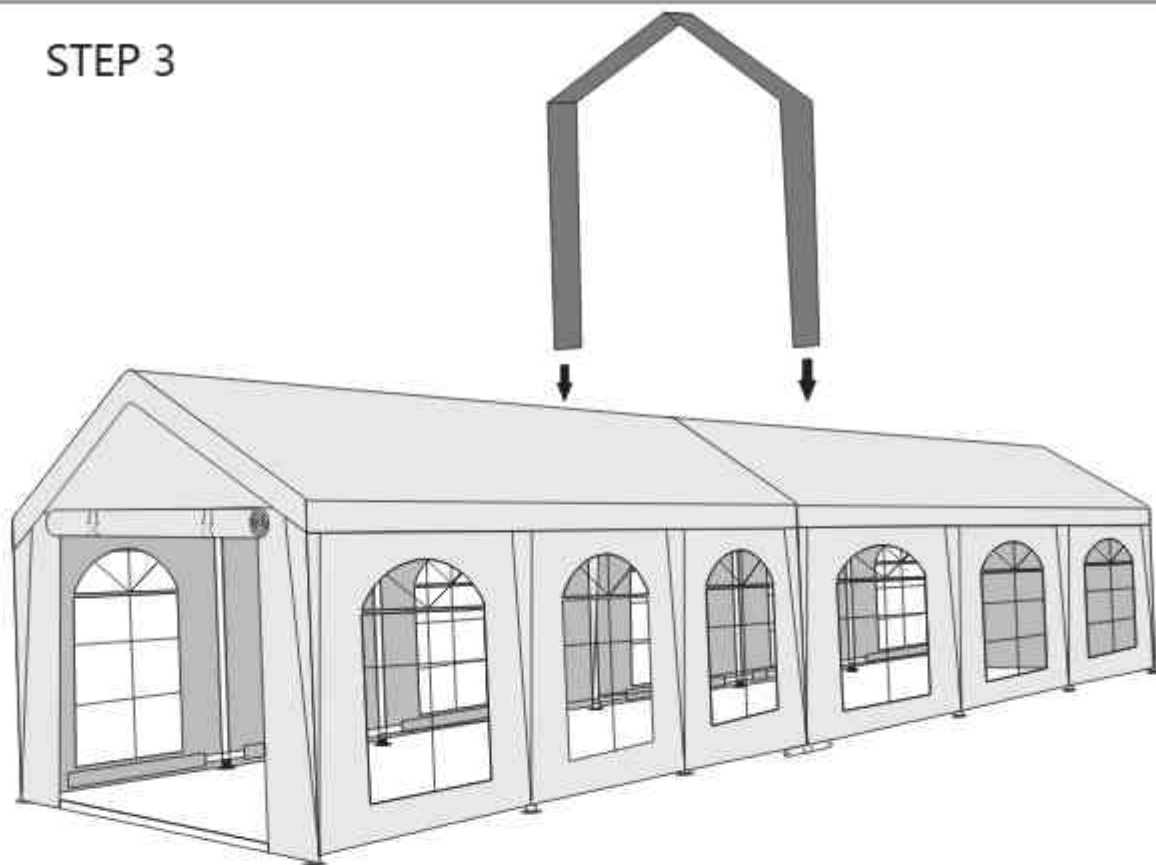

STEP 4



Ⓕ X4

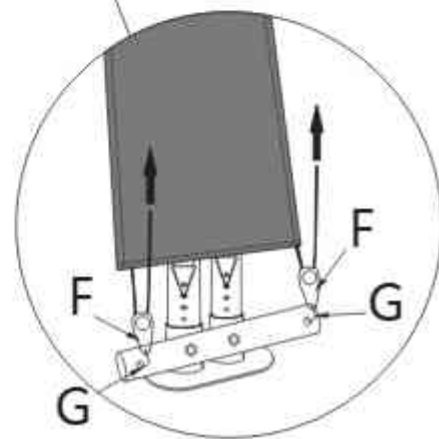
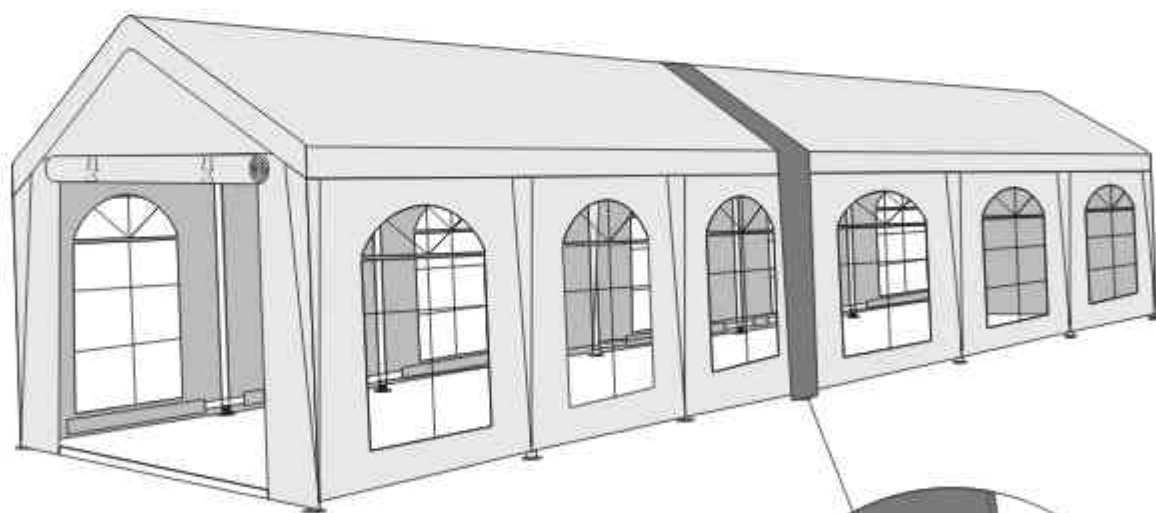

S

Ⓖ X4